

规格书

WWT230-04-106

6M 工业镜头

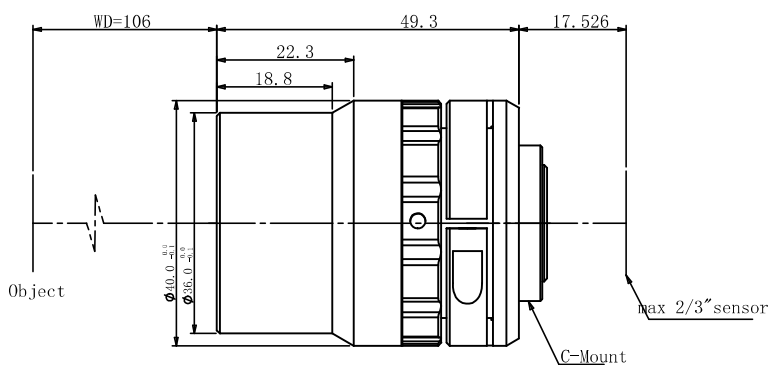

光学参数

放大倍率 β (x)	0.4
物方工作距 WD (mm)	106
支持 CCD 尺寸 (Φ mm)	11.0(2/3")
像方 F/#	6.0
焦距 (mm)	37.17
数值孔径 NA	0.0333
物方分辨率 (μ m)	10.1
物方景深 DoF (mm)	3.0
像方 MTF30 (lp/mm)	118
TV 畸变 (%)	-0.021

视野范围 (mm × mm)

1/1.8" (7.13x5.37)	17.82x13.43
1/1.8" (7.43x4.9)	18.58x12.25
2/3" (8.45x7.1)	21.13x17.75

机械参数

相机接口	C
镜头总长 (mm)	49.3
是否同轴光 / 可调光栏	否 / 否

